

SS-80-PNB/SWB (80mm Swivel Braked Top Plate Castor Polyurethane Tyred Wheel)

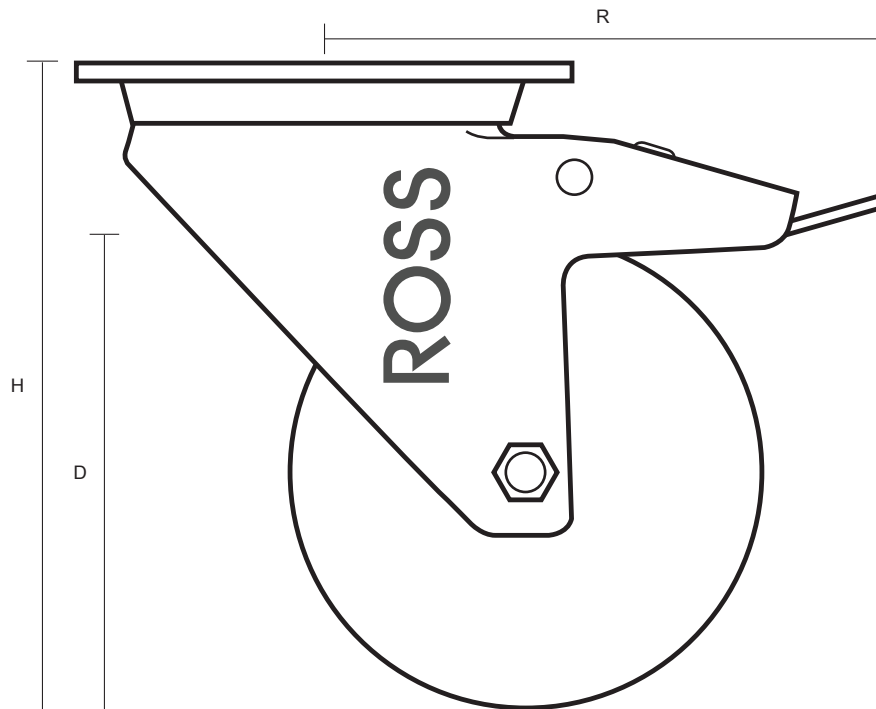
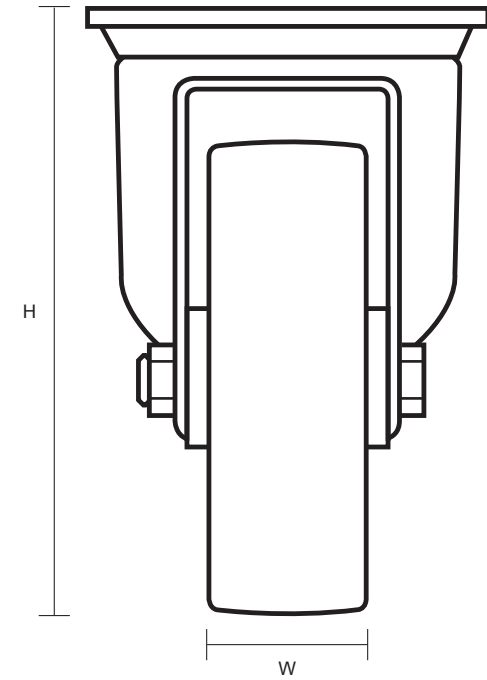
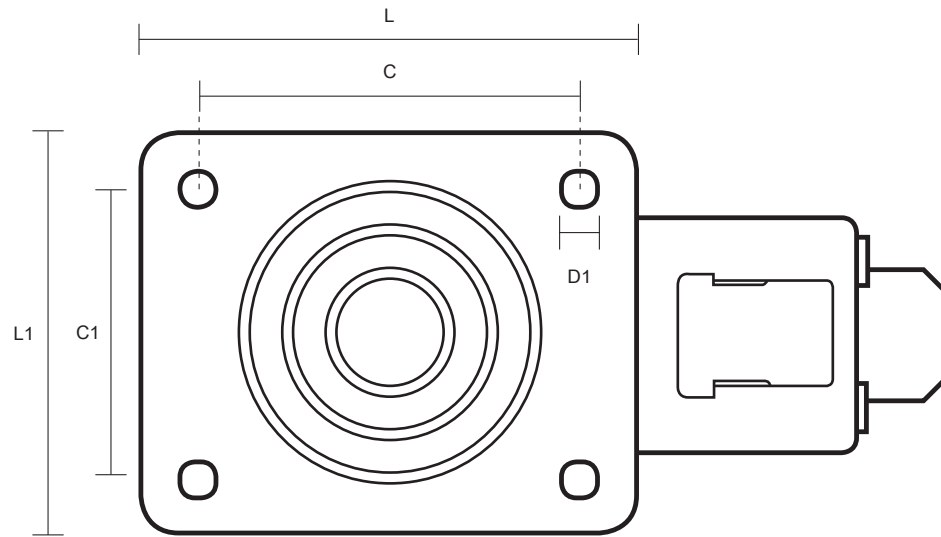

Castor Dimensions - Key		
D	Wheel Diameter	80mm
L	Plate Dimension Length (mm)	105mm
L1	Plate Dimension Width (mm)	85mm
C	Plate Hole Centers length (mm)	80mm
C1	Plate Hole Centers width (mm)	60mm
D1	Plate Hole Diameter (mm)	8mm
H	Total Castor Height (mm)	108mm
W	Tread Width (mm)	27mm
R	Swivel Radius (mm)	120mm